

KIA VENGA 2010↑

PU Side Mouldings

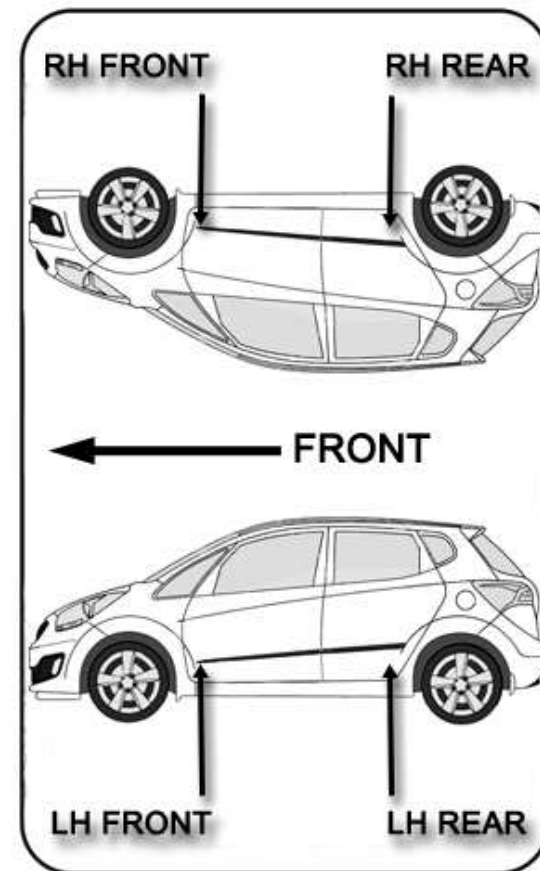
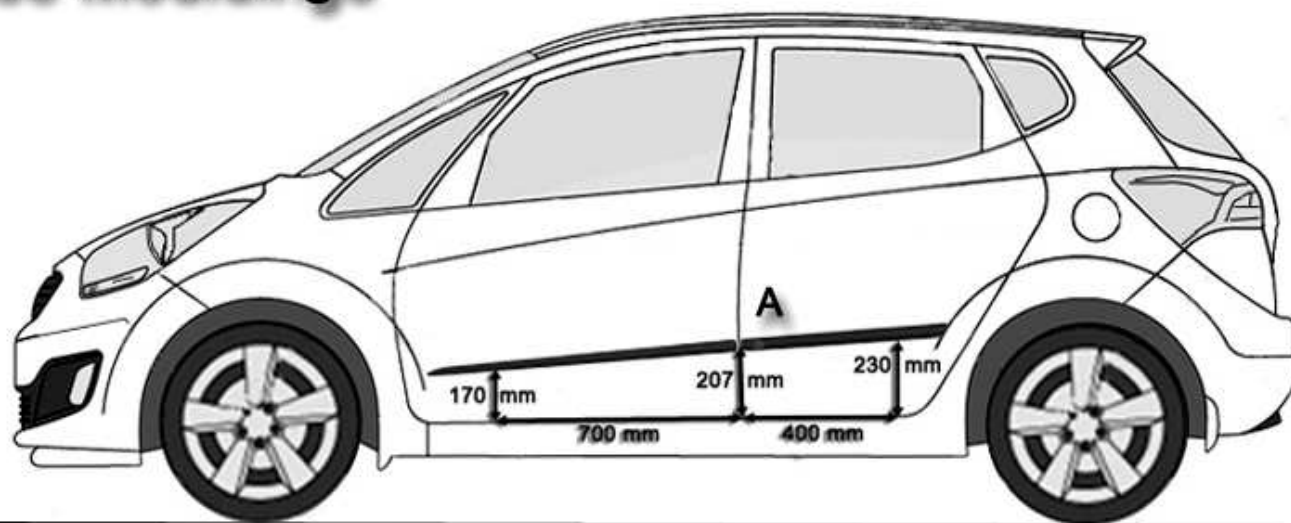

Degrease/entletten/degraisser/ontvetten
Alcohol/Alkohol/Alcool/Alcohol

1

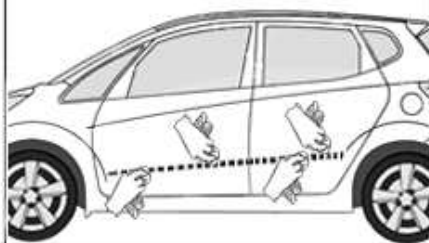

20-40 °C

2

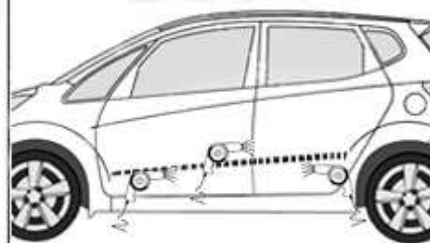

3

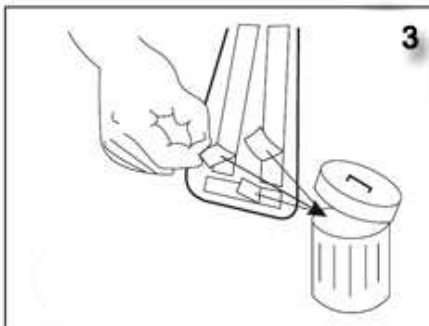

4

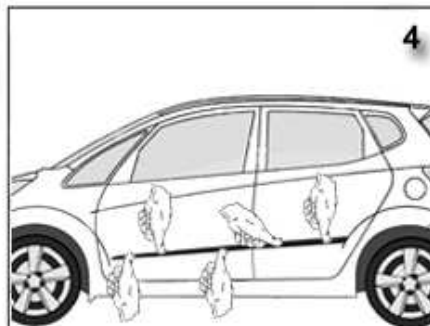

48h



5

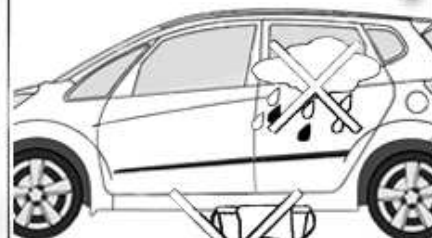

ledere cm goed aandrukken !!
Press very carefully every cm !!
Sehr fest andrucken jeden cm !!

