

Thule Rapid System Kit 1633

> Instructions

NISSAN Leaf, 5-dr Hatchback, 10- / *11-

*North America

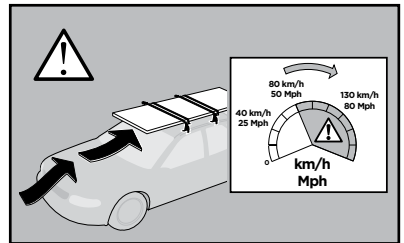
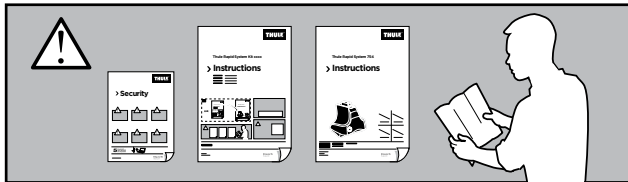
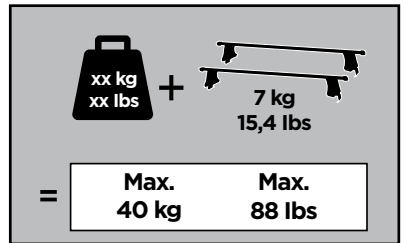
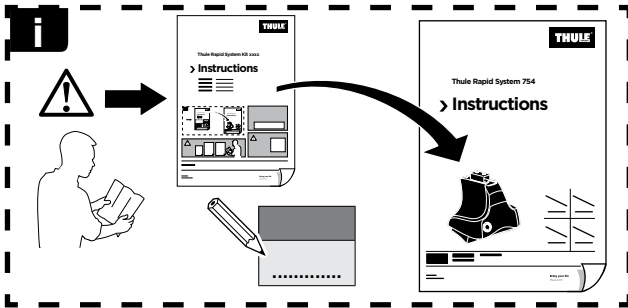

ISO 11154-E

141633

C.20121115
519-1633-01

Bring your life

thule.com



373 x1

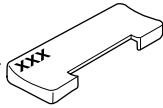

374 x1

375 x1

376 x1

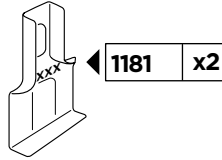
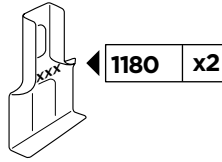

x1

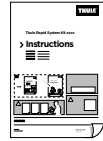

x1

1

| | X (scale) | X (mm) | X (inch) |
|--|-----------|-------------|-------------------------------------|
| NISSAN Leaf, 5-dr Hatchback, 10- / *11- | 41 | 1061 | 41 ³/₄ |

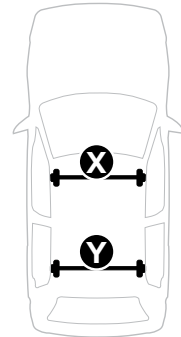
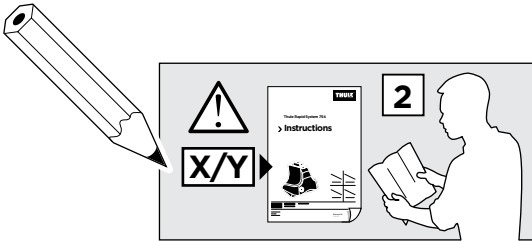

| | Y (scale) | Y (mm) | Y (inch) |
|--|-------------|------------|-----------|
| NISSAN Leaf, 5-dr Hatchback, 10- / *11- | 31,5 | 966 | 38 |

2

NISSAN Leaf, 5-dr Hatchback, 10- / *11-

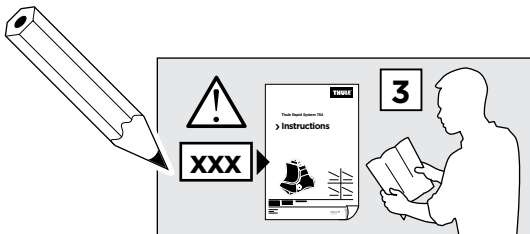
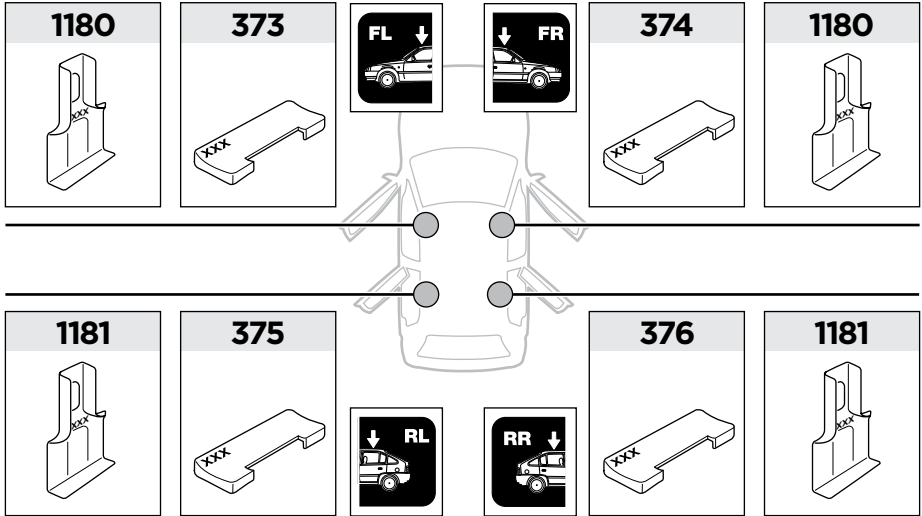

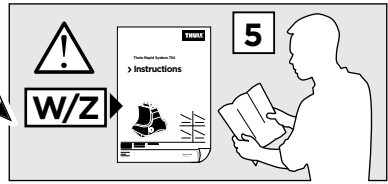
3

| | W (mm) | Z (mm) | W (inch) | Z (inch) |
|---|------------|------------|-----------|-----------|
| NISSAN Leaf , 5-dr Hatchback, 10- / *11- | 280 | 710 | 11 | 28 |

