



Thule Rapid System Kit 1571

> Instructions

Audi A5, 2-dr Coupé, 07-16 / *08-17

Audi S5, 2-dr Coupé, *08-17

Audi A5 Sportback, 5-dr Hatchback, 09- / *10-

Audi S5 Sportback, 5-dr Hatchback, *10-

*North America

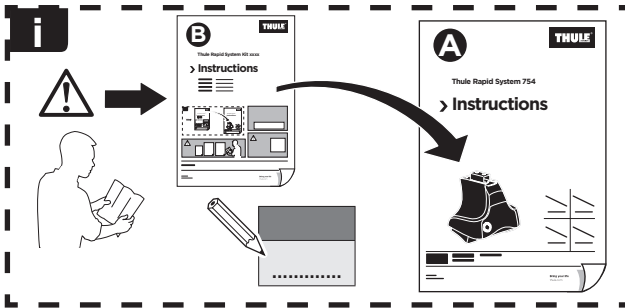
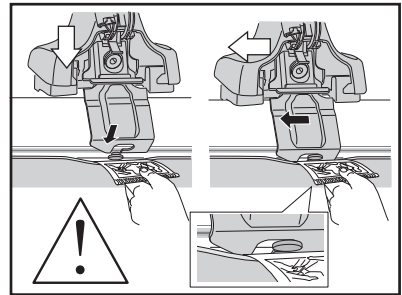
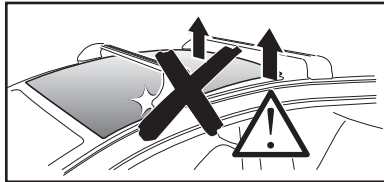

| | | | | |
|---|--------|-------|----------|--|
| | | + | | |
| | xx kg | | 7 kg | |
| | xx lbs | | 15,4 lbs | |
| = | 2-dr | Max. | Max. | |
| | | 50 kg | 110 lbs | |
| = | 5-dr | Max. | Max. | |
| | | 60 kg | 132 lbs | |

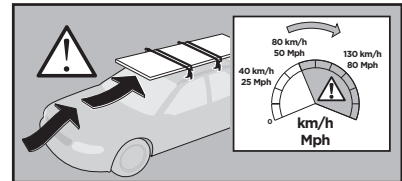
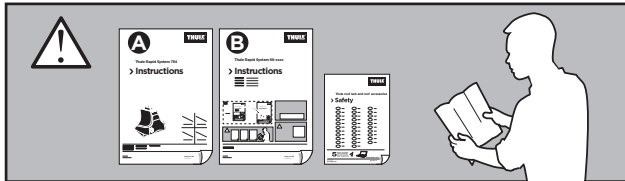

ISO 11154-E

141571

C.20161121
519-1571-07

Bring your life

thule.com

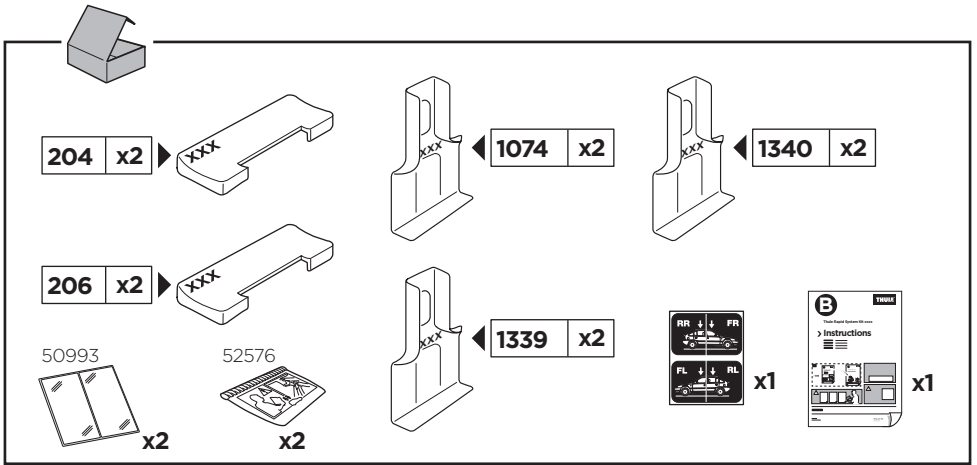

1

| | X (scale) | X (mm) | X (inch) |
|---|-----------|-------------|------------|
| Audi A5 , 2-dr Coupé, 07-16 / *08-17 | 39 | 1041 | 41" |
| Audi S5 , 2-dr Coupé, *08-17 | 39 | 1041 | 41" |
| Audi A5 Sportback , 5-dr Hatchback, 09- / *10- | 39 | 1041 | 41" |
| Audi S5 Sportback , 5-dr Hatchback, *10- | 39 | 1041 | 41" |

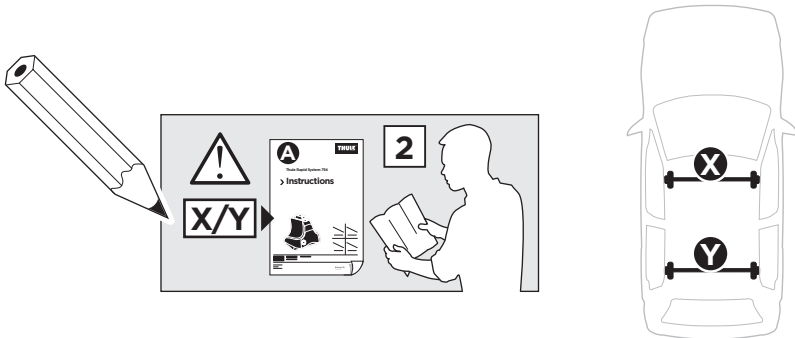

| | Y (scale) | Y (mm) | Y (inch) |
|---|-----------|-------------|--------------------------------------|
| Audi A5 , 2-dr Coupé, 07-16 / *08-17 | 36 | 1011 | 39 ³/₄" |
| Audi S5 , 2-dr Coupé, *08-17 | 36 | 1011 | 39 ³/₄" |
| Audi A5 Sportback , 5-dr Hatchback, 09- / *10- | 37 | 1021 | 40 ¹/₄" |
| Audi S5 Sportback , 5-dr Hatchback, *10- | 37 | 1021 | 40 ¹/₄" |

2

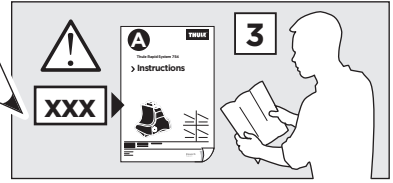
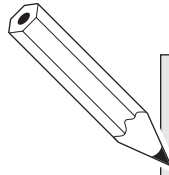

Audi A5, 2-dr Coupé, 07-16 / *08-17

Audi S5, 2-dr Coupé, *08-17

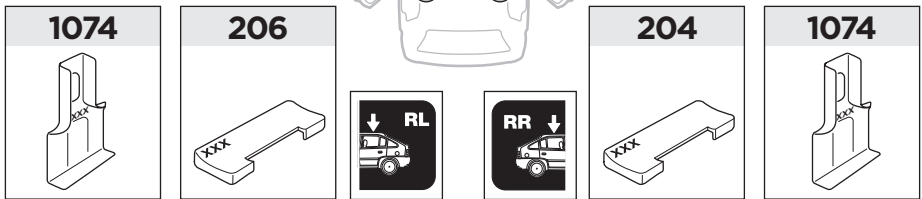
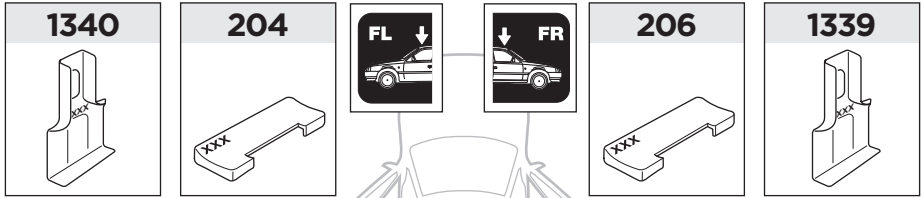

Audi A5 Sportback, 5-dr Hatchback, 09- / *10-

Audi S5 Sportback, 5-dr Hatchback, *10-

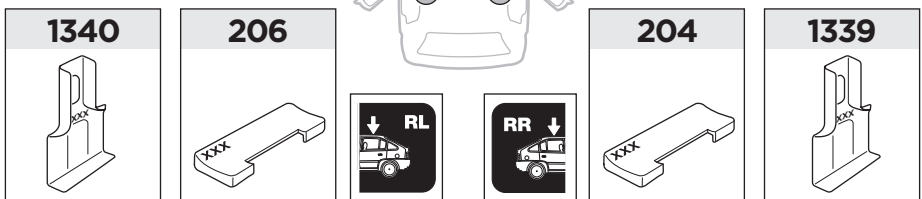
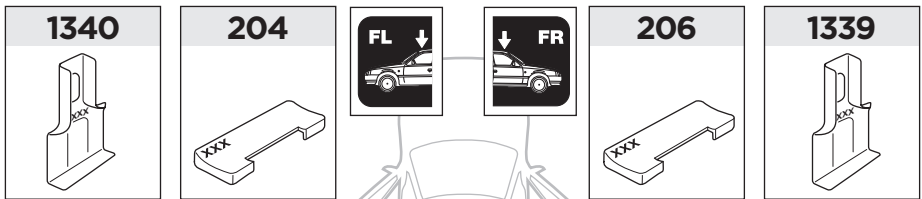

3

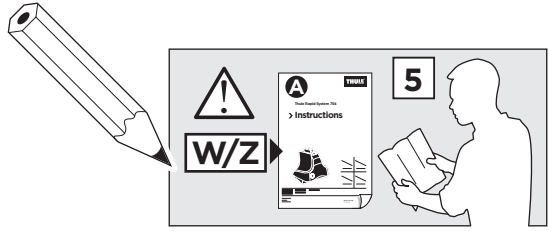

| | W (mm) | Z (mm) | W (inch) | Z (inch) |
|---|--------|--------|----------|----------|
| Audi A5 , 2-dr Coupé, 07-16 / *08-17 | 160 | 705 | 6 1/4" | 27 3/4" |
| Audi S5 , 2-dr Coupé, *08-17 | 160 | 705 | 6 1/4" | 27 3/4" |

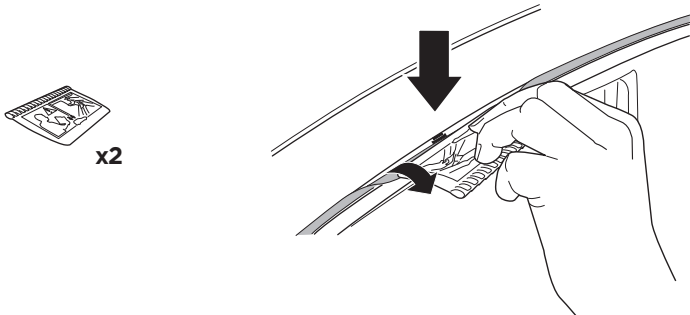
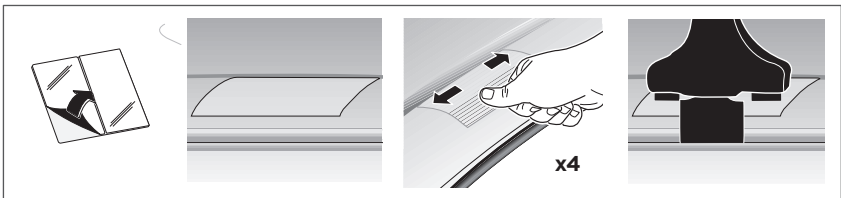
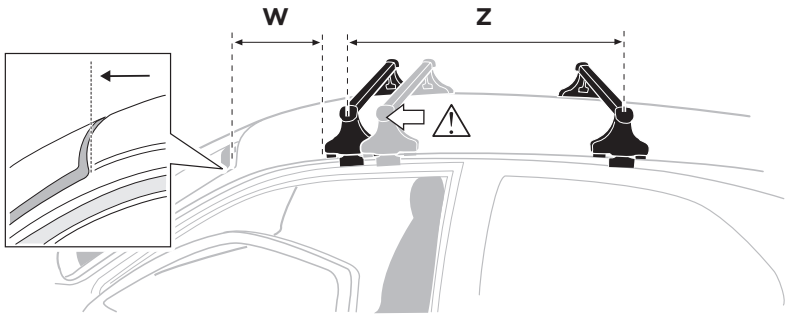

4

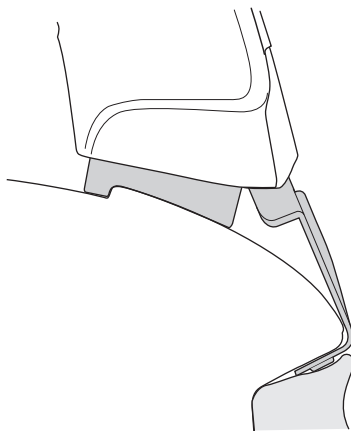
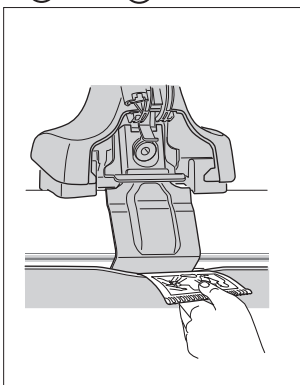
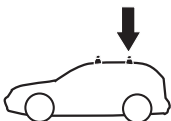
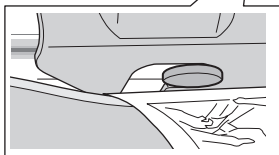
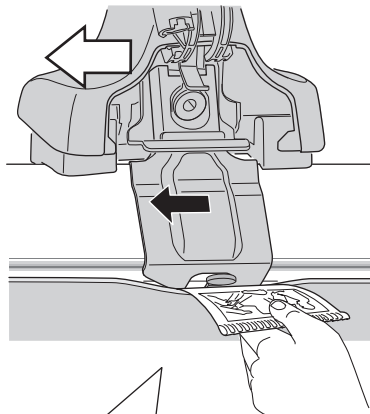
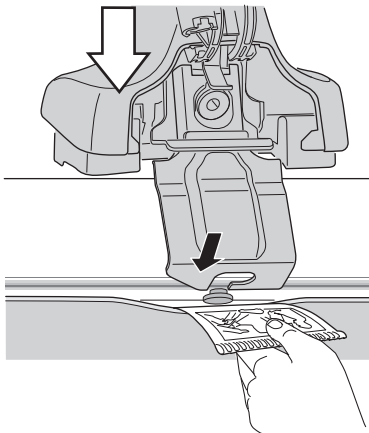
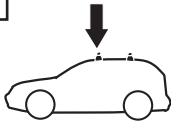

3

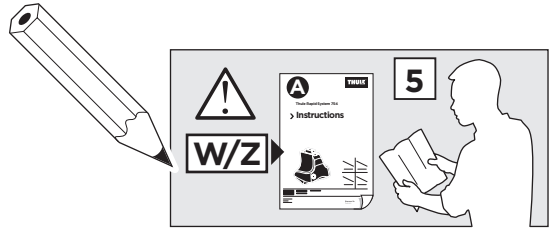

| | W (mm) | Z (mm) | W (inch) | Z (inch) |
|---|--------|--------|----------|----------|
| Audi A5 Sportback , 5-dr Hatchback, 09- / *10- | 130 | 720 | 5 1/8" | 28 3/8" |
| Audi S5 Sportback , 5-dr Hatchback, *10- | 130 | 720 | 5 1/8" | 28 3/8" |

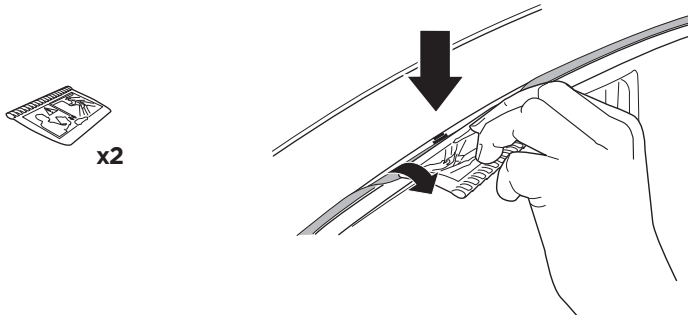
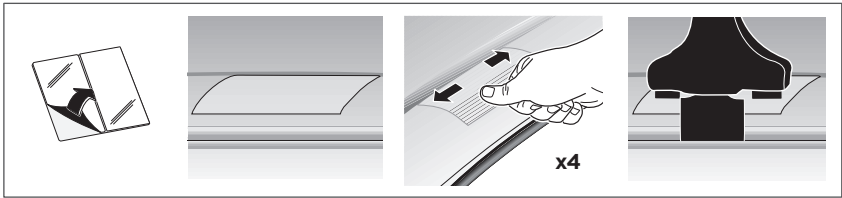
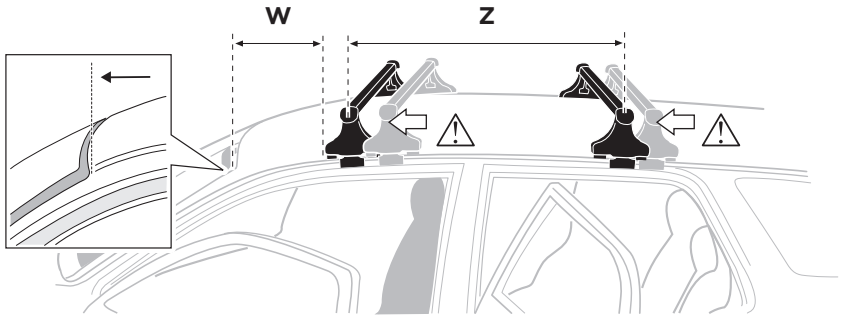

4

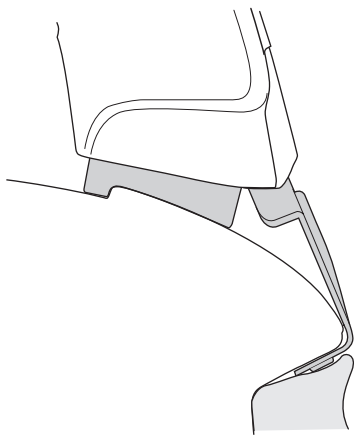
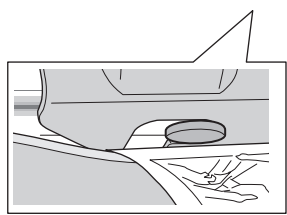
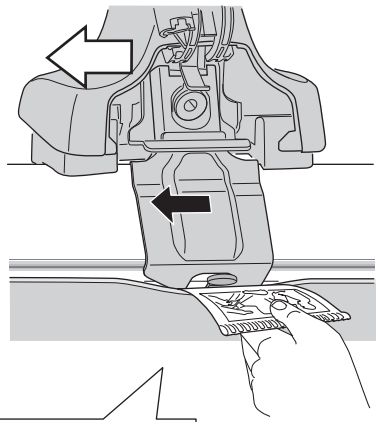
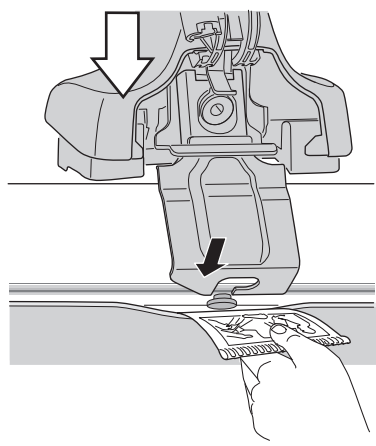



Thule Sweden AB, Box 69, 330 33 Hillerstorp, SWEDEN
Thule Inc., 42 Silvermine Road, Seymour, Connecticut 06483, USA



info@thule.com
Phone: 800-238-2388



www.thule.com